

# MOVING YOU ALWAYS TOWARDS TOP

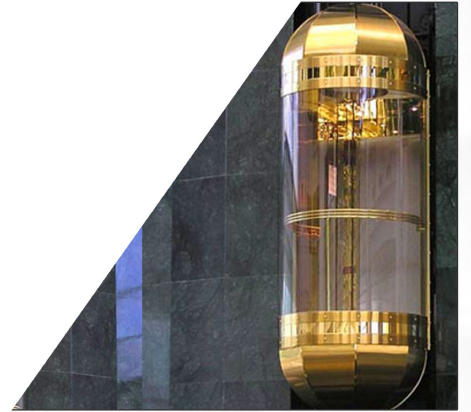

# ABOUT IDEAL ELEVATOR

Whether it's an office building, and educational institute or a hospital, the use of lifts or elevators is indispensable. And when it comes to quality nothing can beat the kind offered by Ideal elevators.

The range of products we offer is varied and we make sure each and every product has its own exclusive design and finishing. We meet domestic as well as industrial installation requirements, in compliance with all the required norms.

We boast of an impressive client base by delivering quality products and best-in-class services to our customers. We put in continuous efforts to achieve customer satisfaction, something we attach a great deal of importance to.

If you are looking for best Elevator company in Kolhapur, Sangli Miraj, Chiplun, Ratnagiri, Kankavli, Swantwadi, Goa, Pune & Other Nearest City then choosing us would be the best bet. We happen to be the best lift company in Elevator field.



# PASSENGER ELEVATOR

Passenger elevators need to be strong and well built. After all, it's about the safety of passengers. The good news is that Ideal Elevators, being the best passenger lift company in Elevator field, offers one of the sturdiest lines of passenger elevators.

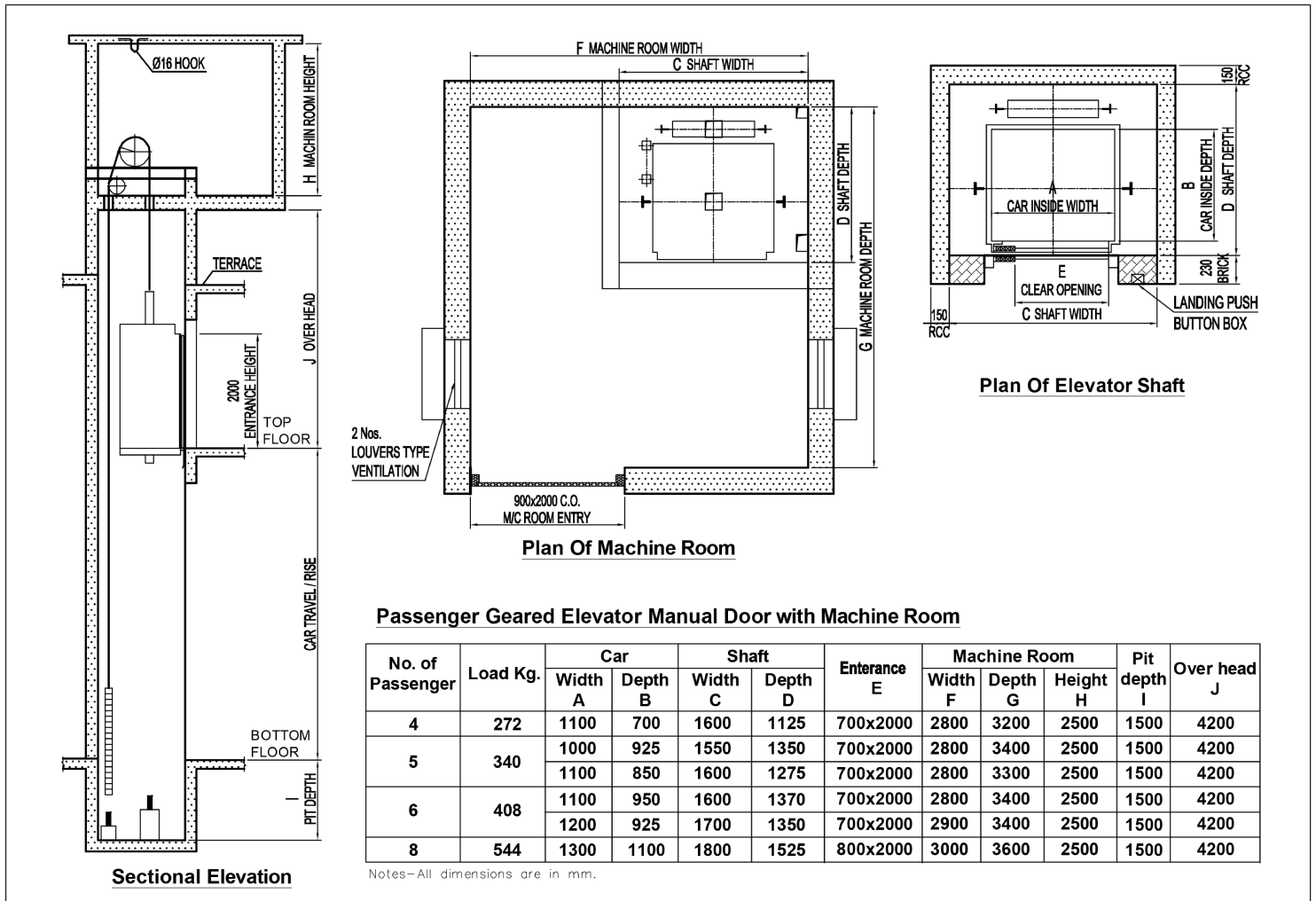

# AUTO PASSENGER ELEVATOR

Passenger elevators need to be strong and well built. After all, it's about the safety of passengers. The good news is that Ideal Elevators, being the best passenger lift company in Elevator field offers one of the sturdiest lines of passenger elevators.

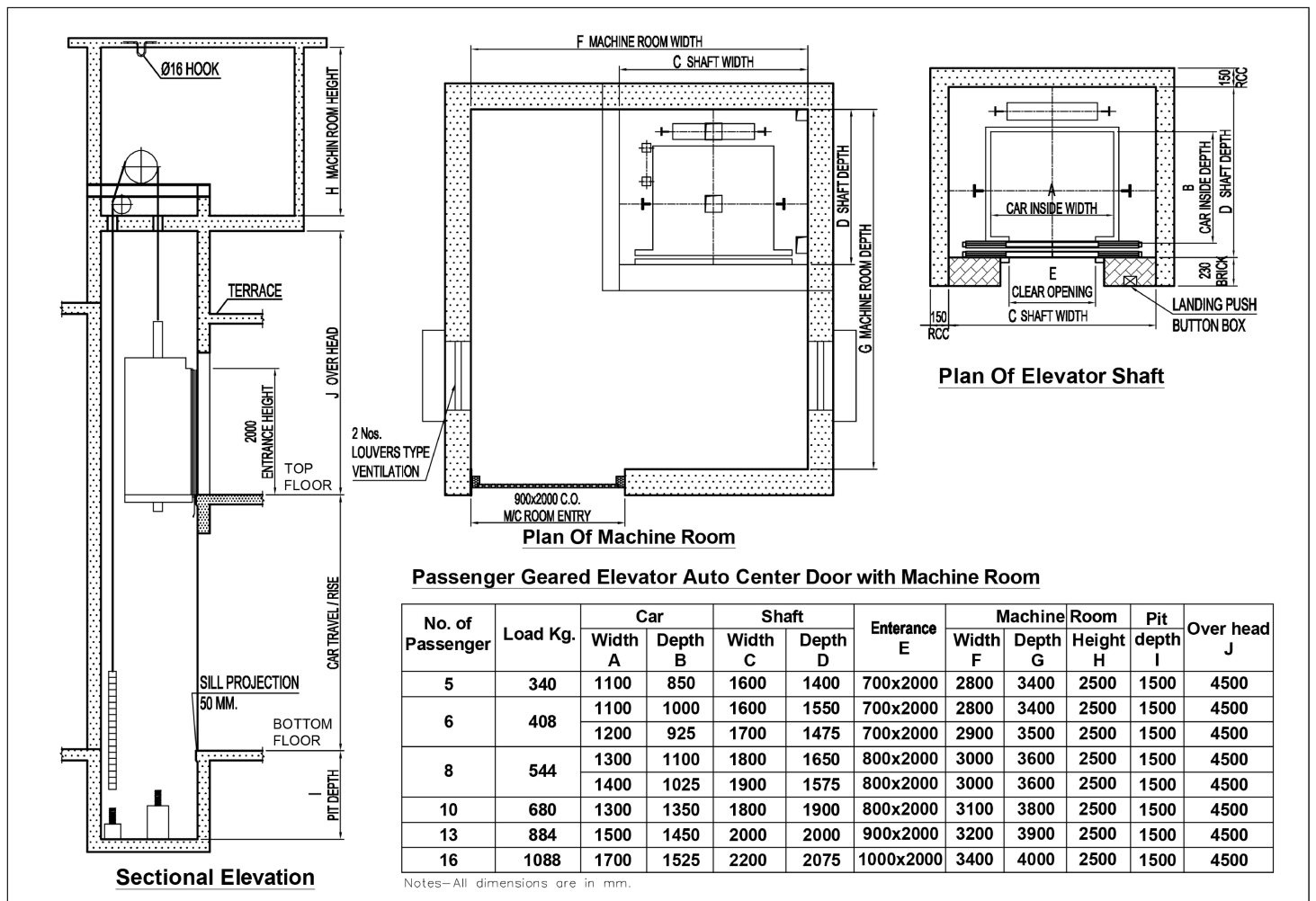



# AUTO MRL PASSENGER ELEVATOR

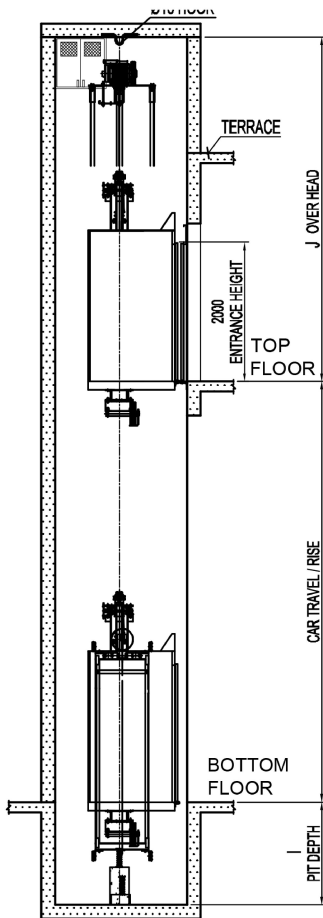

**Sectional Elevation**

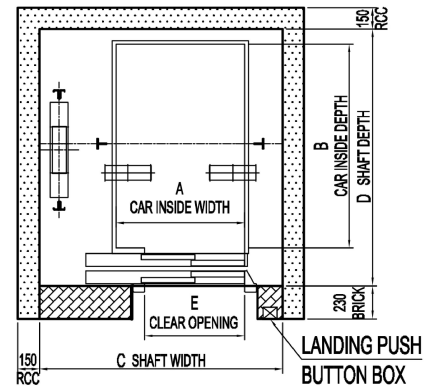

**Plan Of Elevator Shaft**

## Passenger Gearless Elevator Auto Telescopic Door (MRL)

No. of Passenger	Load Kg.	Car		Shaft		Opening E	Pit depth I	Over head J
		Width A	Depth B	Width C	Depth D			
6	408	1000	1100	1800	1500	800x2000	1500	4500
8	544	1100	1300	1900	2800	800x2000	1500	4500
10	680	1300	1350	2100	1750	800x2000	1500	4500
13	884	1100	2000	1900	2400	900x2000	1500	4500
16	1088	1300	2000	2100	2400	1000x2000	1500	4500
20	1360	1550	2000	2750	2400	1000x2000	1500	4500

Notes—All dimensions are in mm.



# CAPSULE ELEVATOR

Glass lifts or capsule lifts are uncommon lifts introduced on the outside essence of the structure or in the entryway or at a spot where it can improve the height and look of building. Capsule Lifts have extravagant insides, enormous straight-forward glass boards giving all encompassing perspective on the encompassing, appropriately called as the trimmings of a structure.

Capsule lifts assembling request specific learning and cutting edge innovation. There are a few distinct choices relating to their structure that are accessible. They can have base lit marble floors, ringer molded rooftops and lodge outsides. Further, Glass entryways make the container lifts look extremely world-class.

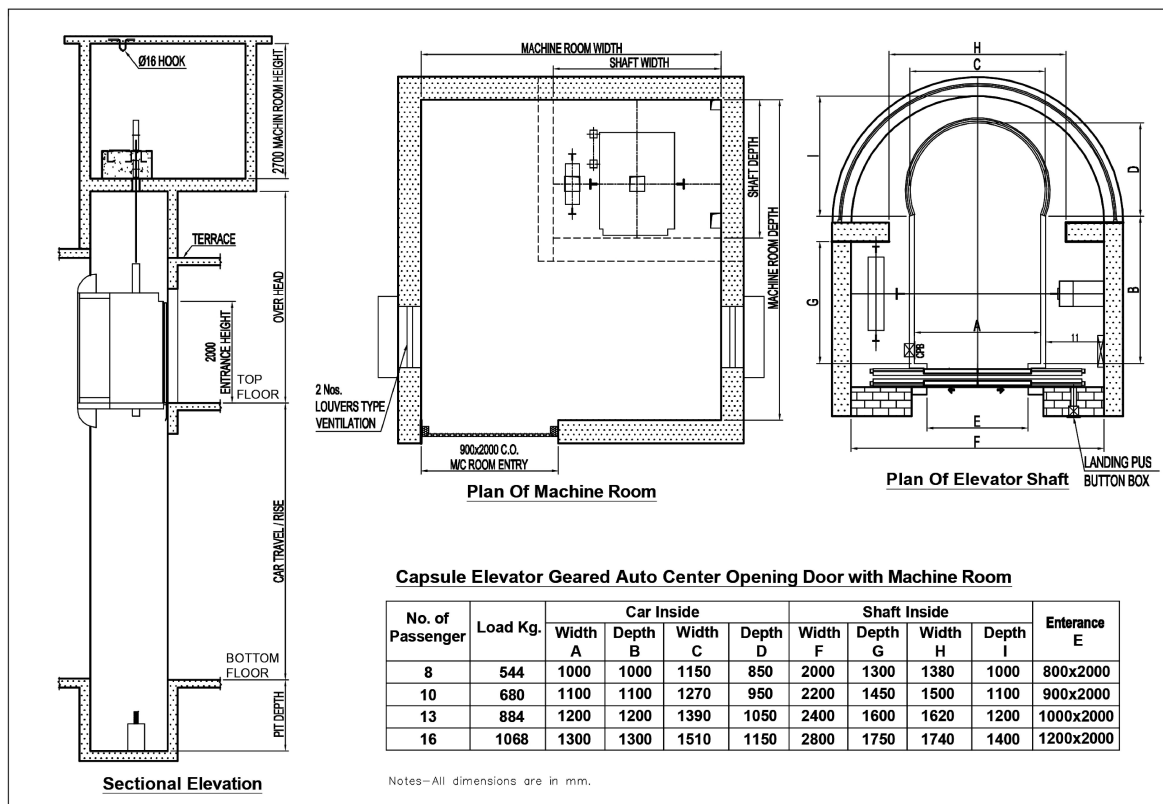



# HOSPITAL ELEVATORS

The use of elevators in hospitals is indispensable. And since the dependence is heavy, any setback on the quality front could prove fatal for patients. And that is why we emphasize on the aspect of quality profoundly. Our hospital elevators have been designed in a way to enable floor-to-floor transportation of patients and equipments, in a completely safe and hassle-free manner.

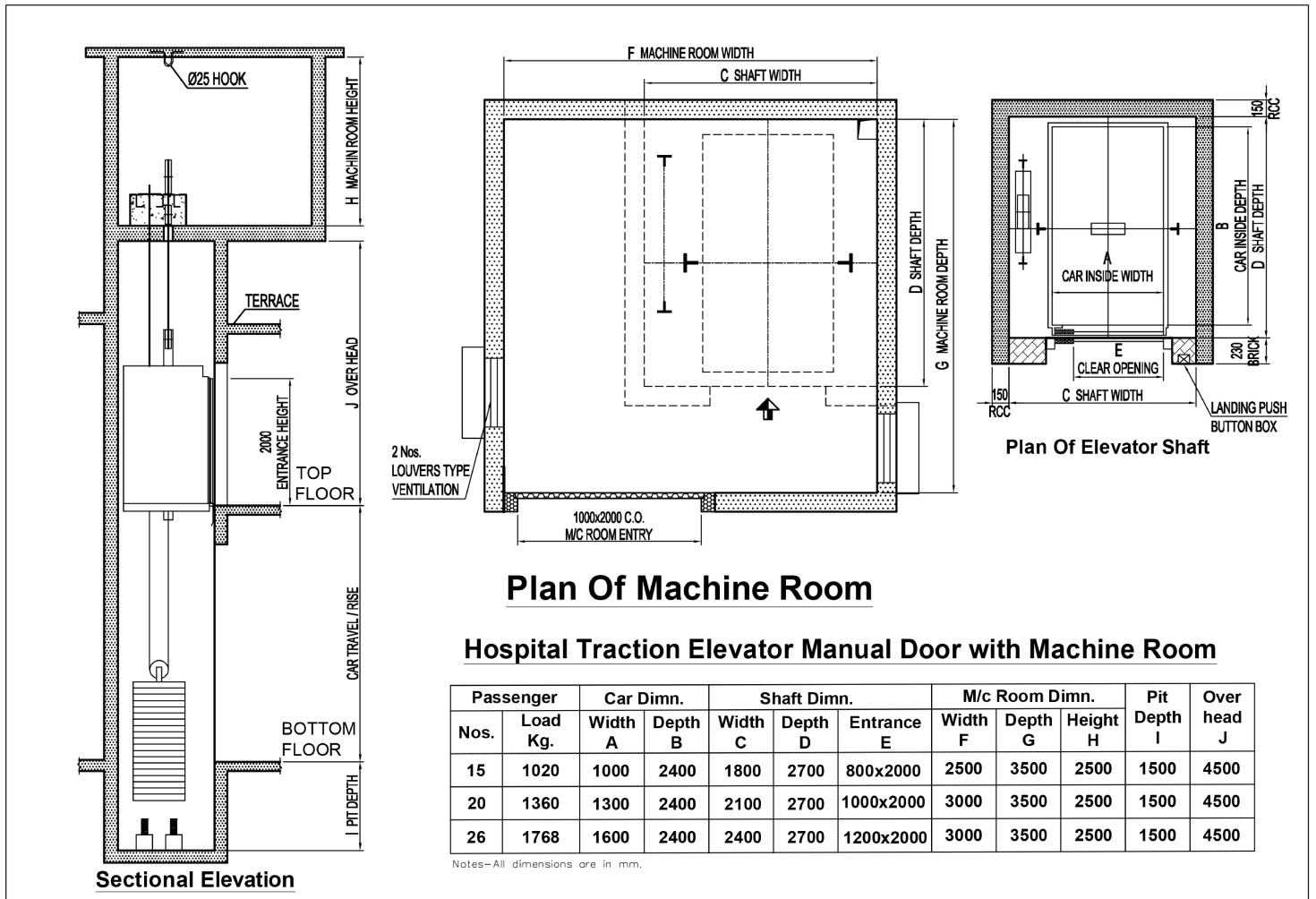



# DUMBWAITER ELEVATOR

We offer a full range of customized and standard industrial Customised as well as hold dumbwaiter elevators. So, you can choose one as per your needs. This appliance doesn't just save on a lot of your time but also makes sure you don't have to take the pain of transporting objects from one floor to another manually.

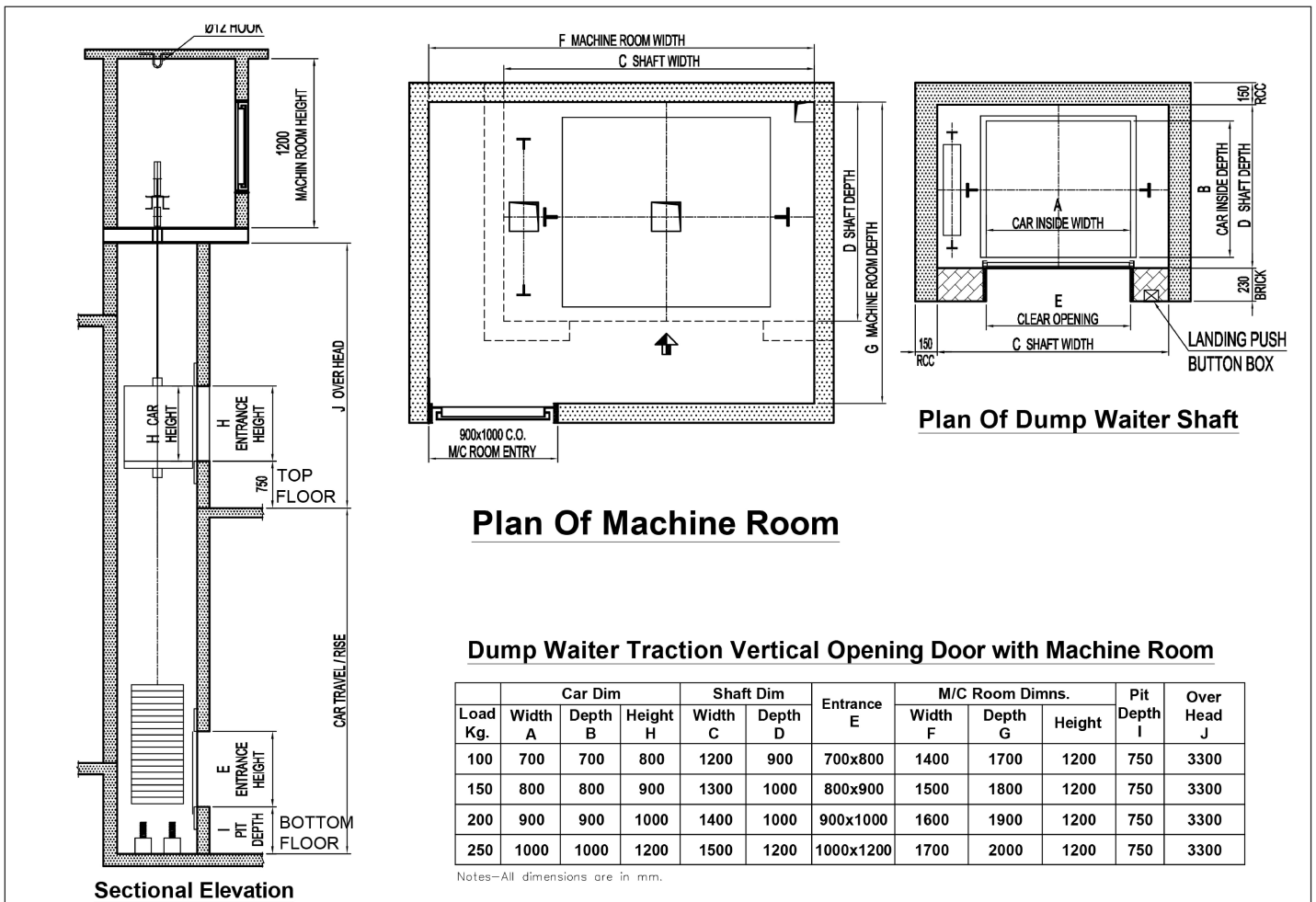



# CAR ELEVATORS

Keeping the specific requirements and demands of our clients in mind, we have brought out a rich assortment of car elevators suited for a wide range of cars & Stairs car. Our products, well in compliance with the industry standards and quality norms, impress our customers heavily. What more? We install car elevators within any time frame set by our clients. Larger in size, our car elevators are designed to bear the load of heavy cars as well.

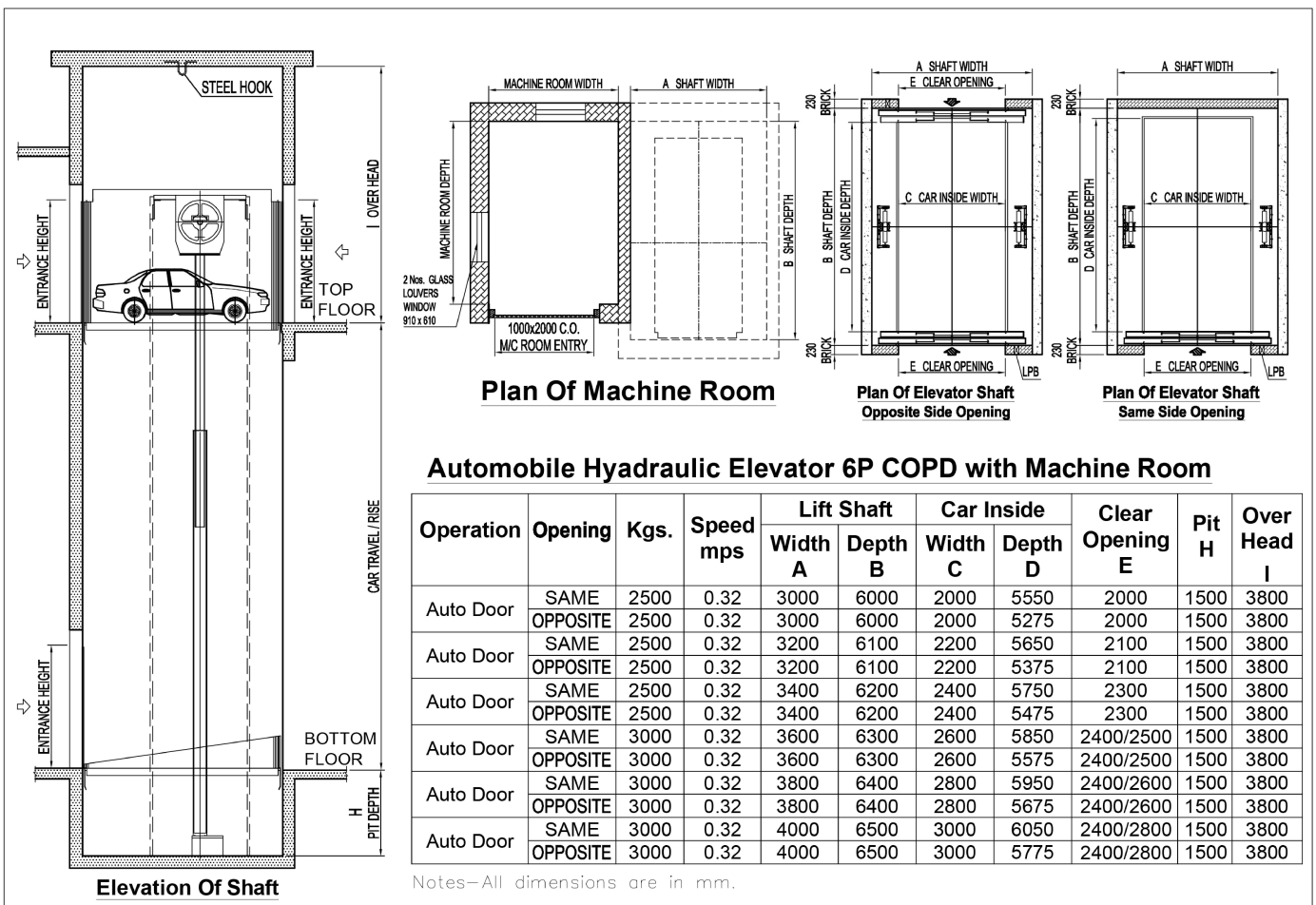



# BUNGALOW ELEVATORS

Our offerings include a range of fine quality Bungalow elevators too. Our elevators find application in terrace flats, showrooms, pent houses, duplex villas, bungalows etc. Our products are not just premium quality but also aesthetically pleasant. With a great finish, they indeed look state-of-the-art. What makes our home elevators stand out is the fact that they remain outfitted with amazing safety features.

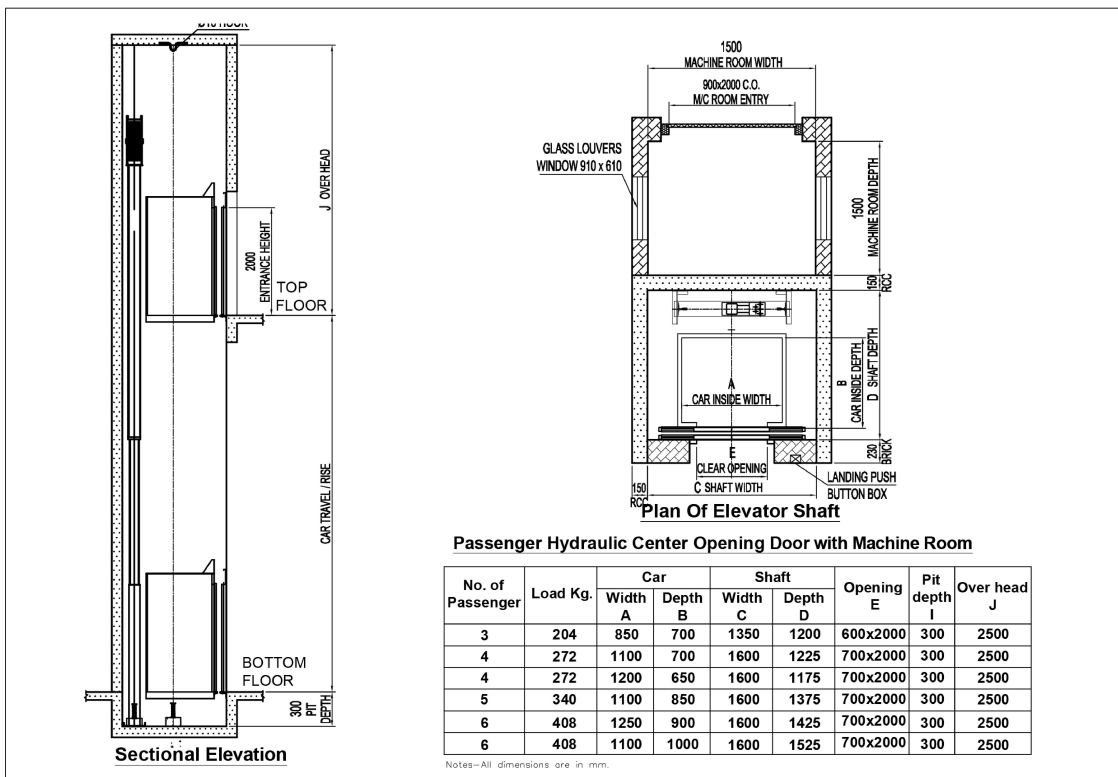

Hydraulic Lift



# STAIR ELEVATOR

These stair lifts are battery worked, have movable seats and the protected way breaking swivel innovation, which guarantees that at each curve or turn you're continually confronting the staircase. Our home stair lifts can be introduced at any living arrangement inside only hours and consume least space of your staircase. They can be introduced inside or outside, through straight, bended and winding staircases relying on your prerequisite.

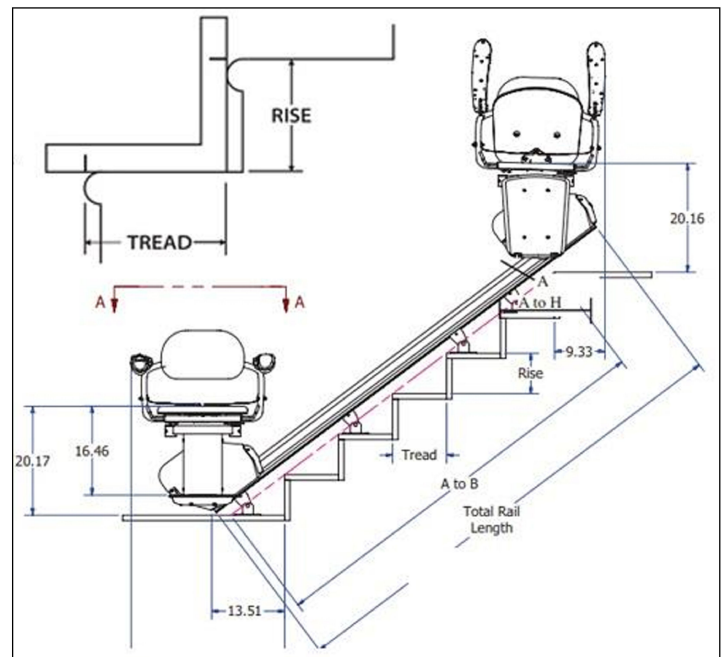
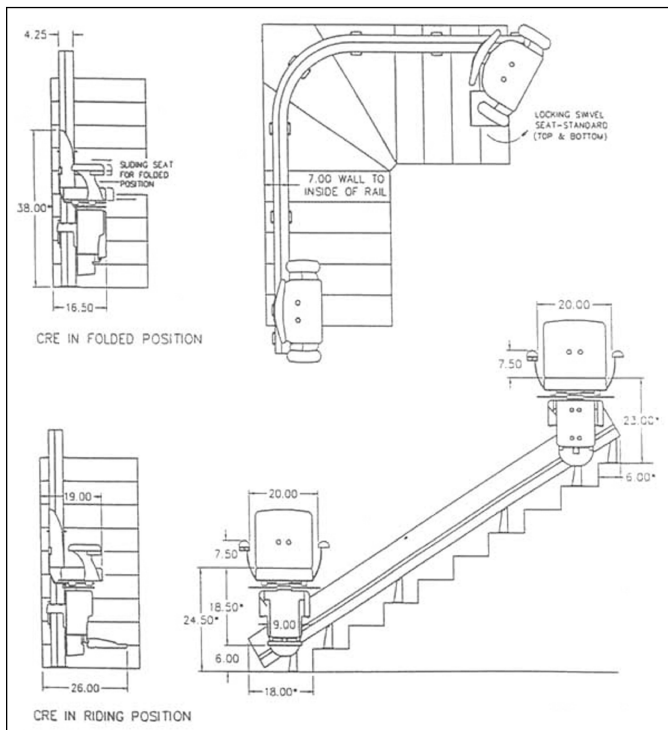

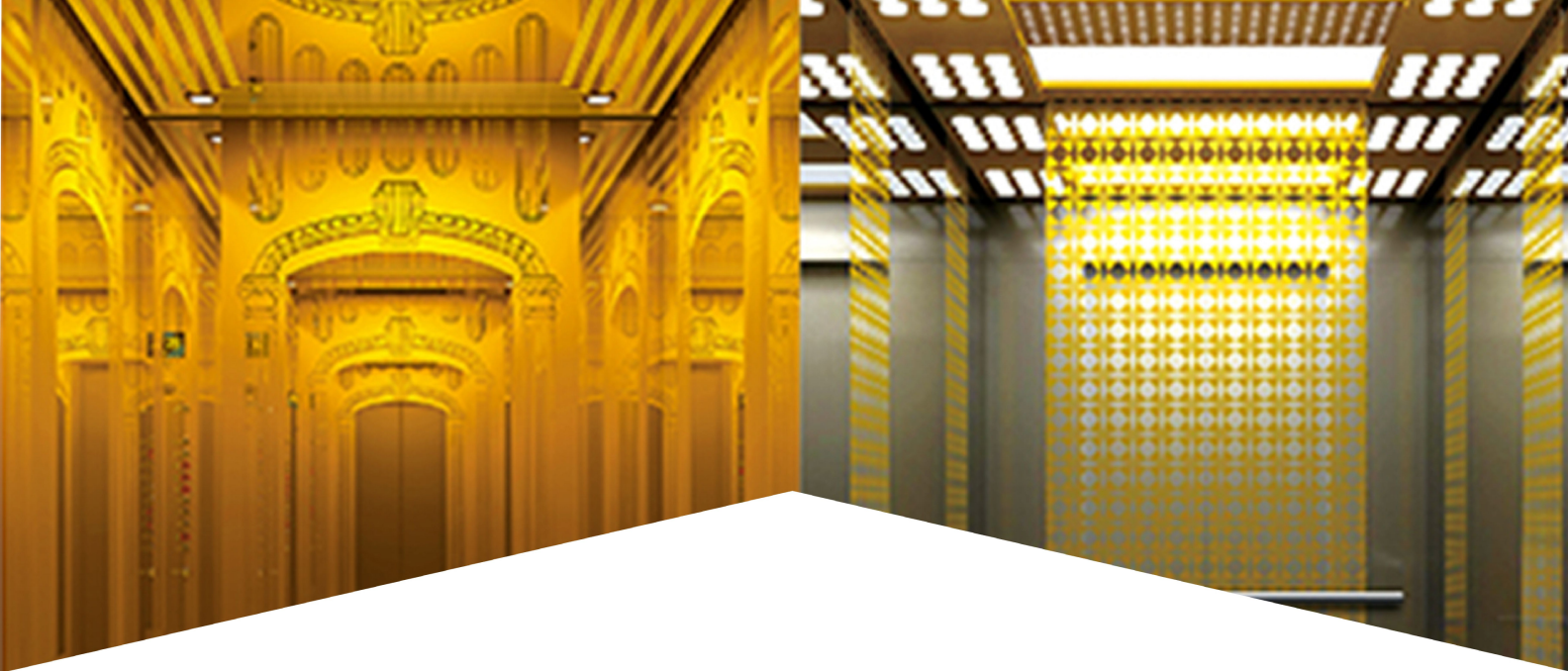

# STAINLESS STILL CABIN

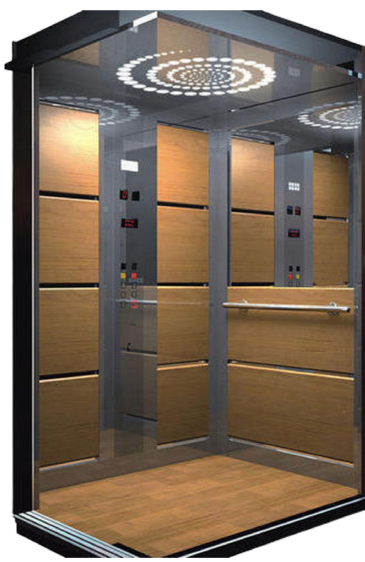

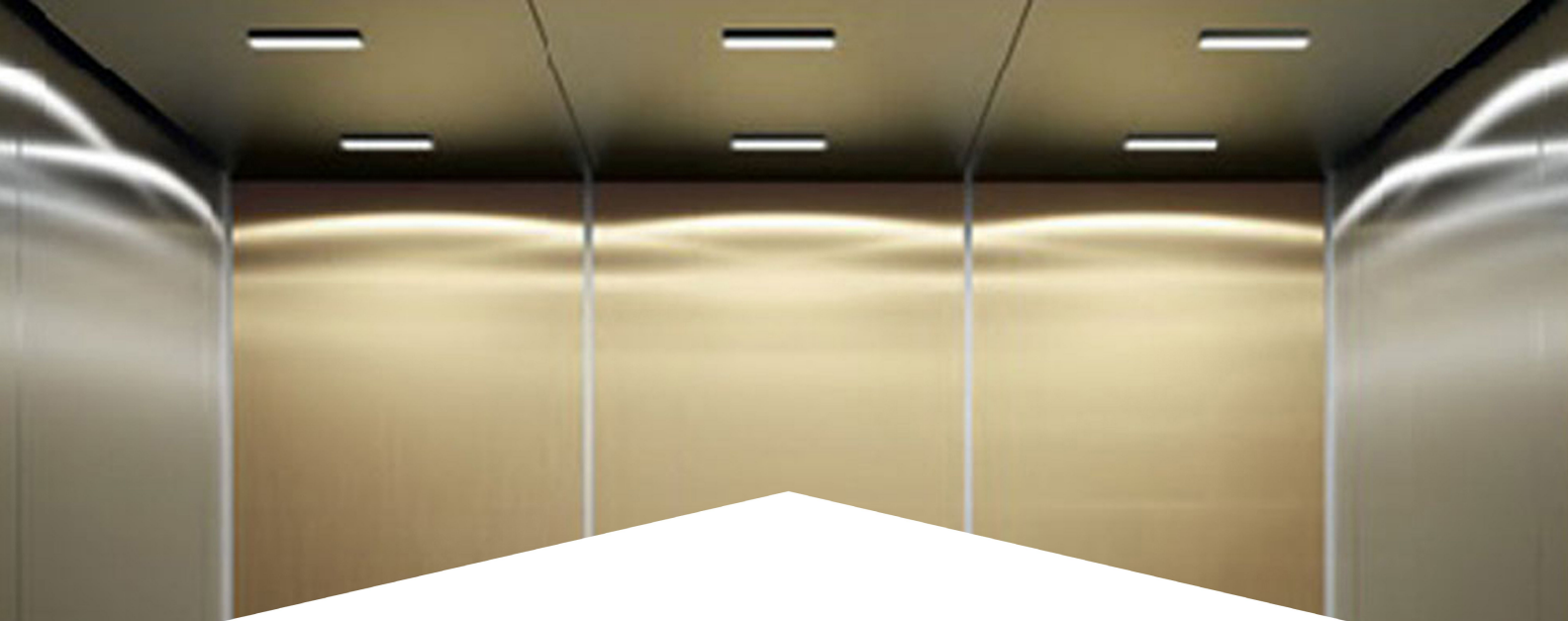

# M. S POWDER COATED CABIN

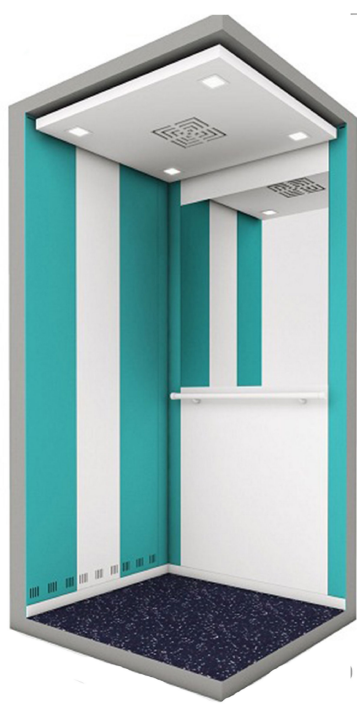

Geared Machine



Gearless Machine



Hydraulic Machine



Control Panel

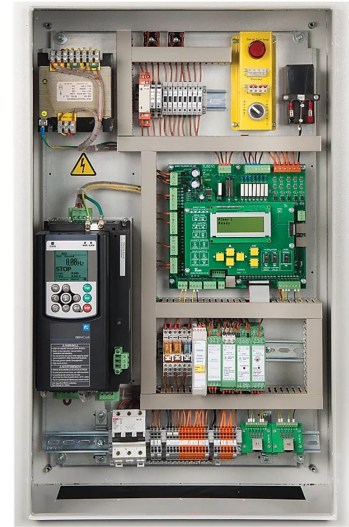

Dumbwaiter

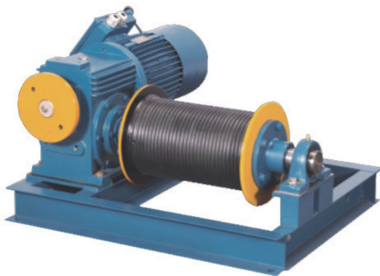

Landing Push Button



Over Speed Governor



Car Push button



ARD Panel

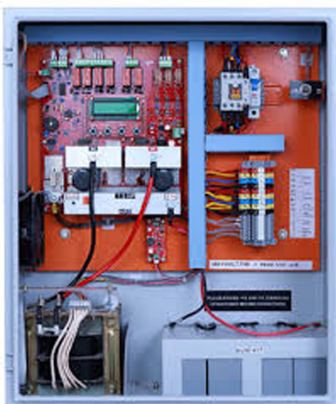

## Manual Elevator Doors

## Auto Elevator Doors

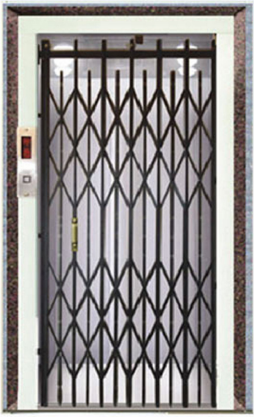

Collapsible Door



Auto Telescopic Door



Imperfoarted Door



Auto Center Opening Door



Swing Door



Auto Big Vision Glass Door



Manuel Telescopic Door



Auto four Pannel Glass Door

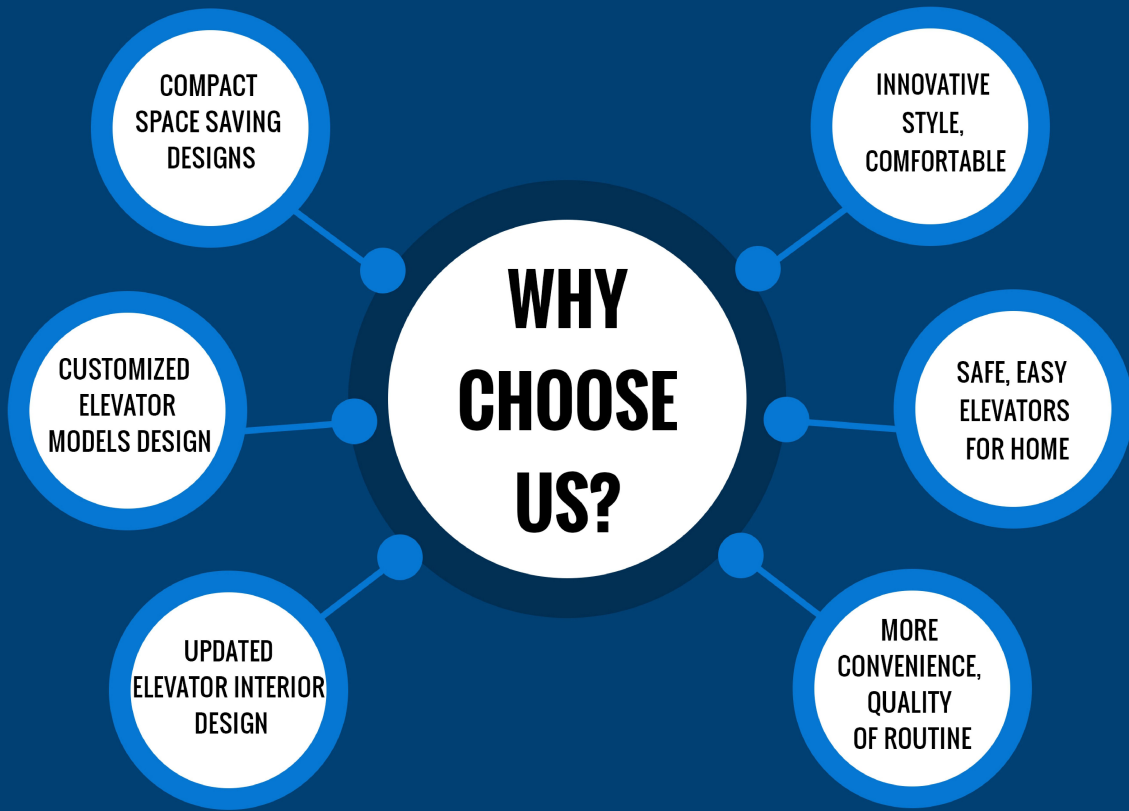

## Contact us

 Aditya Sankul Apartment, Jay Prakash Udhyan,  
Bagal Chouwk, Kolhapur, Maharashtra-416001

 Call : +91 9372 6525 35

 [ideall.elevator@gmail.com](mailto:ideall.elevator@gmail.com)

 Call : +91 9225 5484 82

 [info@ideall.elevator.com](mailto:info@ideall.elevator.com)